

# Data Sheet



Article number: 02150000100

Description: Sealing Clamp S 100 W1

## Measures

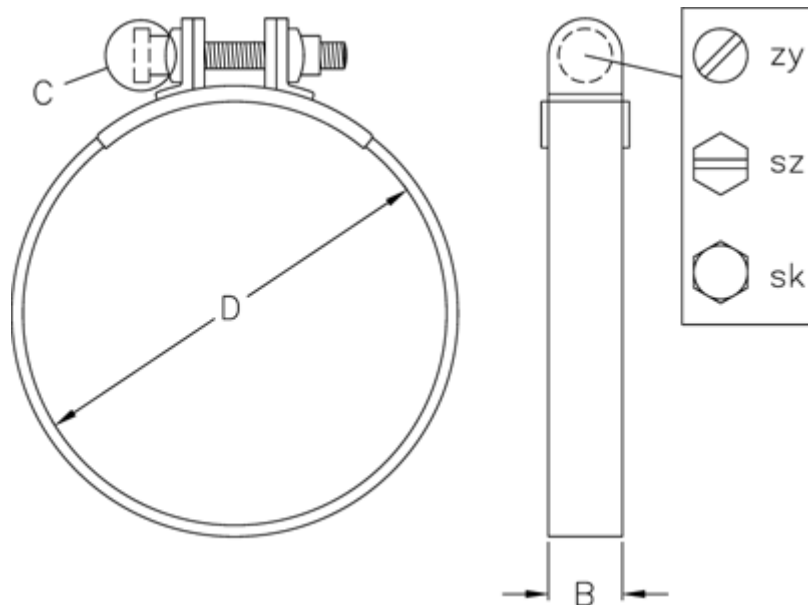

C (screw type) = SZ

Diameter D = 100

Width B = 20